

MDA Series

FEATURES

- Capable of corresponding high frequency .
- Low loss realized with low DCR.
- High performance (Isat) realized by metal dust core.
- 100% Lead(Pb)-Free and RoHS compliant.



APPLICATION

- HVAC
- Audio subsystem
- Digital instrument cluster

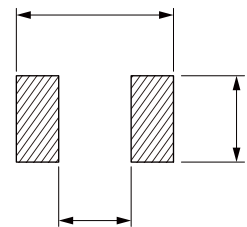
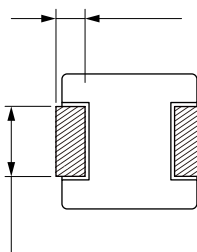
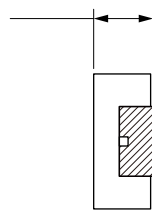
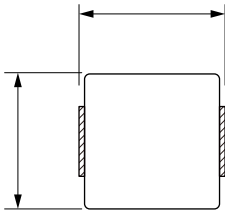

	(μH)			Saturation	($\text{m}\Omega$)
MDA7040-R68M	0.68	$\pm 20\%$	17.0	19.0	4.8
MDA7040-1R0M	1.00	$\pm 20\%$	13.5	16.0	6.6
MDA7040-1R5M	1.50	$\pm 20\%$	12.4	12.5	10.0
MDA7040-2R2M	2.20	$\pm 20\%$	10.0	11.0	14.0
MDA7040-3R3M	3.30	$\pm 20\%$	8.5	9.5	20.0
MDA7040-4R7M	4.70	$\pm 20\%$	6.5	9.0	30.0
MDA7040-6R8M	6.80	$\pm 20\%$	5.5	6.5	45.0
MDA7040-8R2M	8.20	$\pm 20\%$	5.2	6.0	55.0
MDA7040-100M	10.0	$\pm 20\%$	4.8	6.0	65.0
MDA7040-150M	15.0	$\pm 20\%$	3.7	4.5	95.0

	(μH)			Saturation	($\text{m}\Omega$)
MDA7040-220M	22.0	$\pm 20\%$	3.3	4.0	125
MDA7040-330M	33.0	$\pm 20\%$	2.2	3.0	240
MDA7040-470M	47.0	$\pm 20\%$	1.8	2.5	320

△

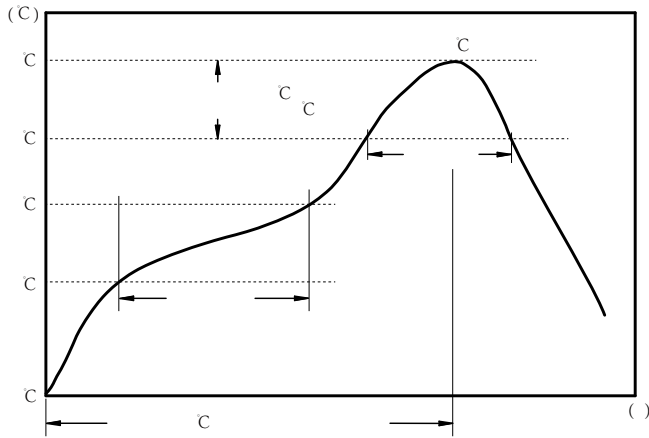

c
c
c

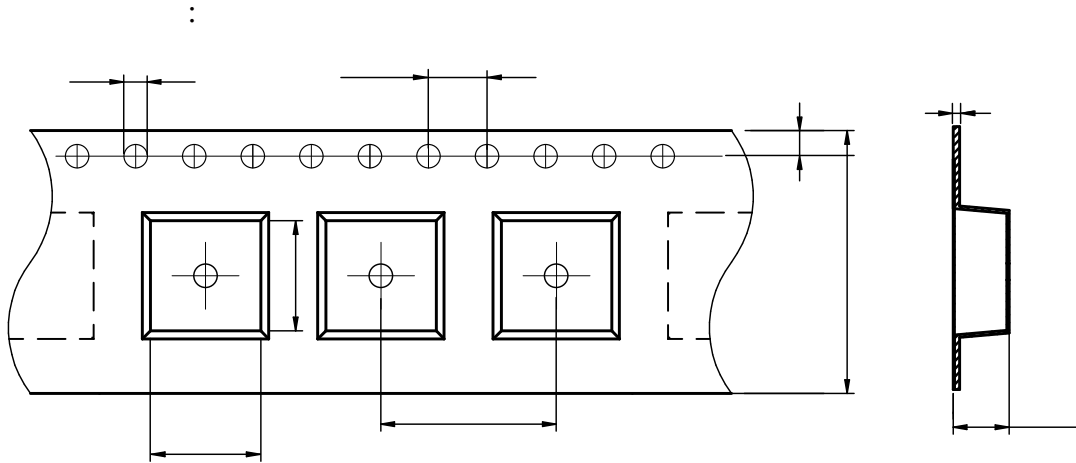

MDA7040	6.9± 0.1	7.5± 0.1	1.5± 0.1	4.0± 0.1	12.0± 0.1	16.0± 0.3	4.3± 0.1	1.75± 0.1	0.40± 0.05

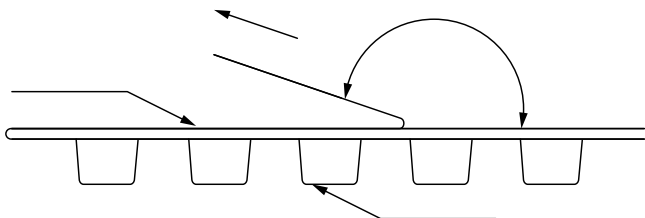

The peel force of top cover tape shall be between 0.1 to 1.3 N

Marking	K+Printing Inductance+period)
---------	-------------------------------

:

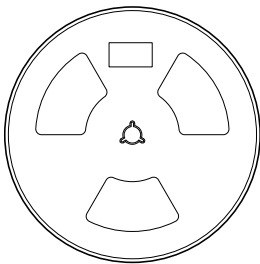
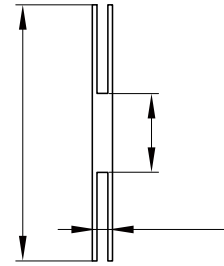
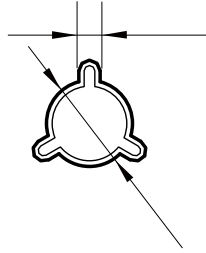
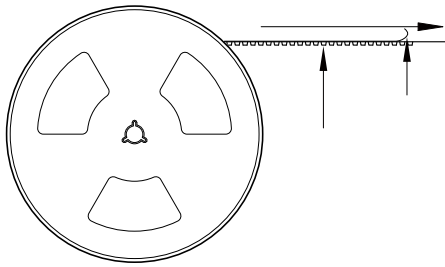

1000Pcs/Reel

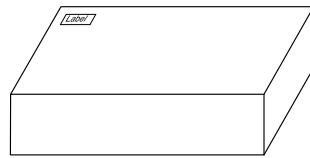

2 Reel /Inner box(2K Pcs)

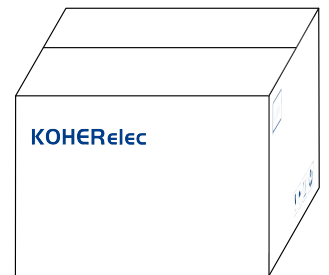

3 Inner box/Carton box(6K Pcs)

:

-
-
-
-
-
-
-
-
-